

High Bay Plus KNX Sensor



Product Code	ITR415-0005
Sensor Technology	Passive Infrared
Power Supply	KNX Bus
Installation environment	Indoor
Mounting height	4 m - 15 m
Current Consumption	5 mA
Brightness Detection	1-1200 lux
Inputs	2 x Digital Input, 1 x Analog Input
Maximum Air Humidity	% 90 RH
Pollution Degree	2
Type of Protection	Flush Mount : IP 20 Surface Mount : IP 44
Temperature Range	Operation (-5°C...45°C) Storage (-10°C...60°C)
Dimensions	70 x 41,8 mm (Φ x H)
Colour	Black and White
Certification	KNX Certified

DESCRIPTION

ITR415-0005 - High Bay Plus KNX Presence Sensor is a multi-functional device suitable for indoor usages with high plus range detection and high ceiling mount capability. It includes 4 independent presence channels that can be used with constant light switch and constant light controller functionality. Independent presence channels can be configured as the automatic or semi-automatic mode for user requirements. Moreover, ITR415-0005 also supports sensor functionality without presence channels for simple usage. Temperature measurements can be made via an integrated temperature sensor and temperature information can be reported to KNX bus. ITR415-0005 also includes 5 independent logic blocks to make logical associations. The logical blocks can be associated with such as “AND”, “OR” and “XOR” logic. The logic input conditions contain presence, brightness, movement and external conditions. The sensor also can be configured as the master or slave mode.

DETECTION RANGE

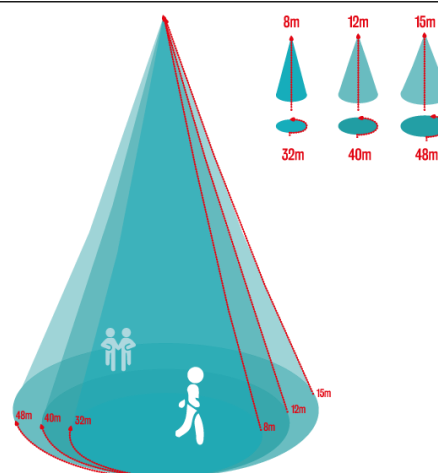



Mounting Height	Walking Across
4 m	16 m
8 m	32 m
12 m	40 m
15 m	48 m

FUNCTIONS

- ITR415-0005 supports presence detection, brightness detection, movement detection, internal and external temperature detection.
- Presence detection, based on a passive infrared sensor, has 4 independently configurable channels with constant light switch and constant light control application.
- ITR415-0005 have 5 logic function blocks and can be set in the logical relation AND/OR/XOR. Each block can control 5 output objects.
- Via 2 digital inputs and 1 analog input, external devices can be connected.
- Switch sensor, switch/dimming sensor, shutter sensor, value/forced operation, scene control, RGB colour control and HVAC mode selection control can be made with buttons that are connected to the inputs.
- Temperature measuring through the integrated sensor, analog input or KNX temperature sensor with the possibility of sending the value on change and periodically to the bus for monitoring the room temperature.
- The device also integrates the “Virtual Card Holder”; the field of application is the hotel room: through a magnetic sensor installed on the door and connected to a digital input, accurate presence information is managed.
- The sensing range for detecting people sitting, walking towards and walking across are different sizes. The sensing range of the detector changes depending on the mounting height.
- With the function of the constant light controller: The detector keeps the brightness at a constant value, and it will dim the lights to the corresponding intensity according to the surrounding brightness.

USEFUL INSTALLATION TIPS

As the sensor reacts to temperature changes, the following conditions should be avoided:

-  Avoid targeting the sensor toward the objects which may be swayed in the wind, such as curtain, tall plants, miniature etc.
-  Avoid targeting the sensor toward the objects whose surfaces are highly reflective, such as mirror, glass and pool, etc.
-  The sensor should be mounted away from heat sources such as air conditioning, lights, heating vents etc.

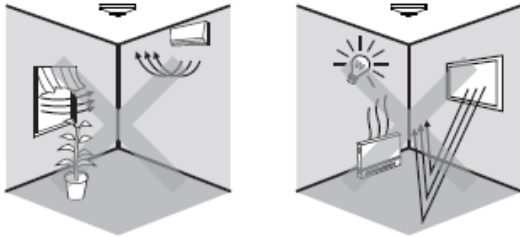

IMPORTANT NOTES

- For planning and construction of electric installations the appropriate specifications, guidelines and regulations in force of the respective country have to be complied.
- Special Programming: ITR415-0005 is designed for professional KNX installation. It only can be programmed by ETS software.
- Cable Connections: Ensure making correct connections for Black and Red wires.
- Voltage: The input voltage shall be 21-30 V DC.
- Mounting Location: Installed indoors, to avoid installation near the air-conditioner vent, and be away from the heat source.
- The tightening torque shall not exceed 0.2 Nm.
- Avoid contact with liquids and corrosive gases.

TECHNICAL DRAWINGS

Technical drawings and dimensions for flush mounted and surface mounted sensor models are given below. All dimensions specified for technical drawings are in millimeters.

Flush Mounted :

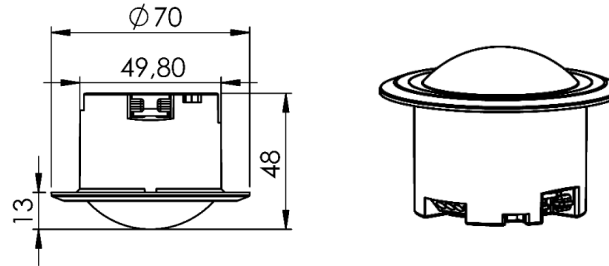

Surface Mounted :

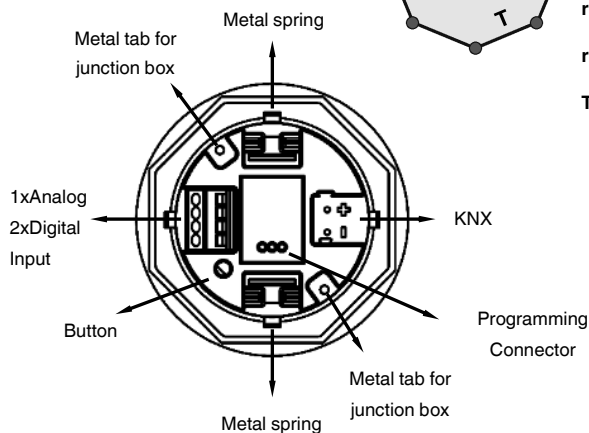
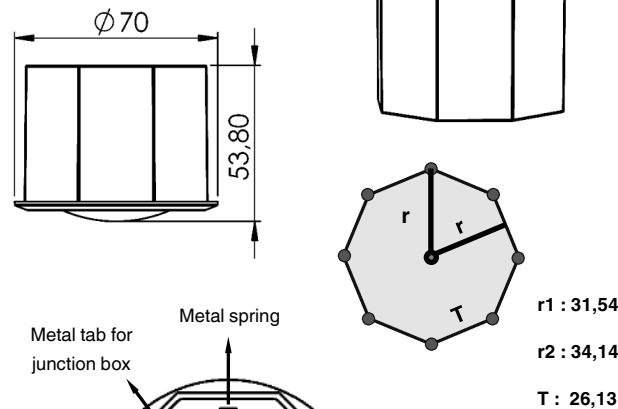

MOUNTING

The device can be mounted either in the ceiling via flush mounting housing or on the ceiling via the optionally available surface-mounted box.

Flush Mount Process:

- First, a slot hole of suitable size for sensor mounting is opened on the ceiling surface to be flush mounted.
- Then, KNX cable and input cable, if any, are connected to the relevant connectors on the sensor.
- The 2 metal springs on the sensor are stretched and then the sensor is attached to the hole on the ceiling. Thus, mounting process is finished.

Surface Mount Process (Optional) :

- First, a hole of suitable size for cables is opened on the ceiling surface.
- Second, the octagonal surface junction box where the sensor will be placed is screwed to the ceiling.
- Then, KNX cable and input cable, if any, are connected to the relevant connectors on the sensor.
- The 2 metal springs on the sensor housing are removed and then the metal tabs are attached to the sensor housing. Then, the sensor is mounted to junction box. Thus, mounting process is completed.

CALIBRATION

There is the option of carrying out a brightness adjustment for the sensor via the brightness detection application with the aid of the ETS parameters and objects.

Calibration Procedure

- Perform the measurement during sufficient daylight ($> 1/2 * \text{setpoint}$).
- Switch off the light source.
- Carry out the measurement of brightness at a defined location with a luxmeter. For instance, lying down at the workplace with a view toward the ceiling and wait until the light is close to being constant. Send the value to the device using the brightness calibration object via ETS as soon as possible after measuring.